

morleys

Stairnosings, Flooring Adhesives & Accessories



Manufactured in the UK



Product Catalogue

Our Value Will Floor You

When you want the perfect finish trust a progressive British manufacturer who has been creating quality flooring accessories since 1986.

With a service that is second to none, competitive prices, free stair nosing measuring service* and a continually expanding product range,

Morleys give you the edge every step of the way.

Fast Free Measuring Service*

Morleys provide a fast free* measuring service for stair nosings which is guaranteed to save you time and money when providing bespoke cut sizes.

Our area sales managers are available to assist with product selection and advise on legislation, in relation to the Building Regulations Part M and the Disability Discrimination Act.

Our managers have extensive knowledge and practical experience with contract installation, maintenance and cleaning.

To arrange your measure contact your local Morleys distributor, area sales manager or the office on 01772 626 700.

Product Sizes

Stair nosings available in stock lengths of:

3.22mtr, 2.75mtr & 2.44mtrs unless otherwise stated

Carpet Metals, Stickdown & Clip-Fit available in:

2.70mtr unless otherwise stated

Bespoke sizes on request for all products

Contents

SECTION 1.

Stair Nosings

HN Range

4. 90° Straight
5. Bullnose
6. 83° Rakeback
7. Chevron

Stair Nosings

SN Range

8. 90° Straight
9. Bullnose
10. 83° Rakeback
11. Budget
12. Castellated

Stair Nosings

DDA Range

13. Heavyweight
14. Slimline

15. Premium Finishes

Inserts

16. Standard Insert Colours
17. MorGrip & Exterior Colours

Angles

18. 83° & 90° Angles
19. Angle Trims

Stair Nosing Extras

20. Fabrications
21. Installation
22. Maintenance
23. Measuring Service

SECTION 2.

Carpet Metals

24. Naplocks
25. Naplocks
26. Cover Strips
27. Cover Strips
28. Special Purpose
29. Special Purpose

SECTION 3.

Stickdown Profiles

30. Stickdown
31. Stickdown

Additional

32. Accessories—Tapes
33. Adhesives
34. Contact Details

Find, select and specify our products with NBS Source



NBS Source
PARTNER



Check out our full range by scanning the QR code

Section 1. Stair Nosings

HN Range 90°

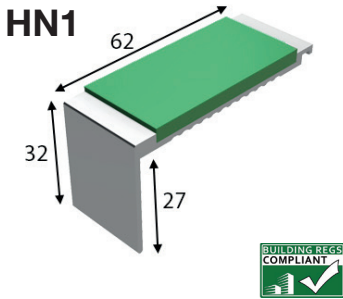

Single Channel Straight 90°

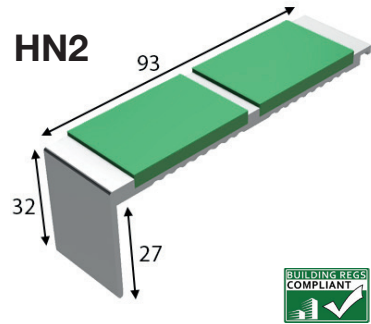

Double Channel Straight 90°

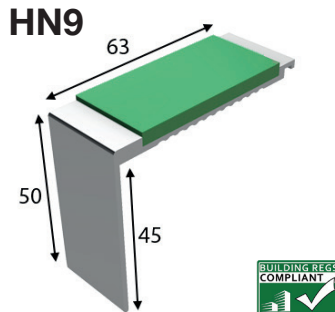

Single Channel Straight 90°

90° profiles for use on square fronted staircases when fitting medium carpets and heavy duty smooth flooring

HN Range Bullnose

HN3

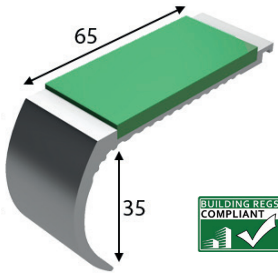

Single Channel Bullnose

HN4

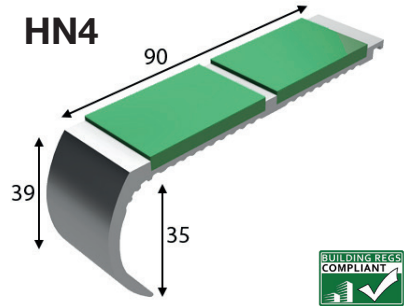

Double Channel Bullnose

HN7

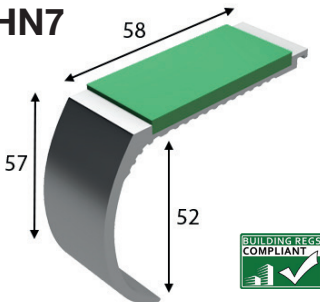

Single Channel Large Bullnose

HN8

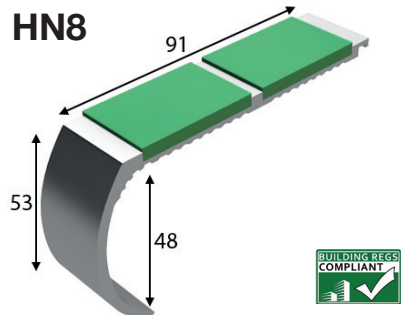

Double Channel Large Bullnose

Bullnose profiles for use on bullnose fronted staircases when fitting medium carpets and heavy duty smooth flooring

HN Range Rakeback 83°

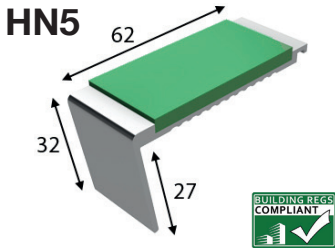

Single Channel 83° Rakeback

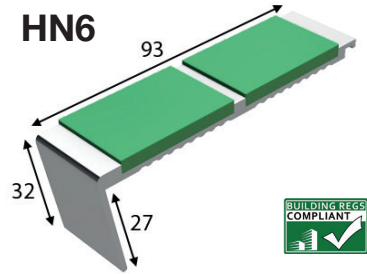

Double Channel 83° Rakeback

83° profiles for use on rakeback staircases when fitting medium carpets and heavy duty smooth flooring

Interlocking Sections

NT1

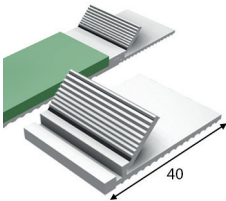

Naplock section used to hold the carpet edge in place

NT3

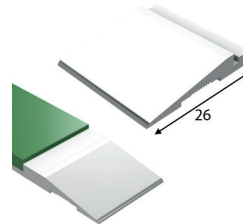

Ramp section for a smooth transition to a flat surface

*Both sections are for use with the Heavyweight range and are available in stock lengths of 3220mm, 2750mm and 2440mm

HN Range Chevron

HN10

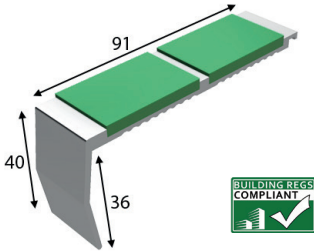

Double Channel Chevron
Fronted (small)

HN12

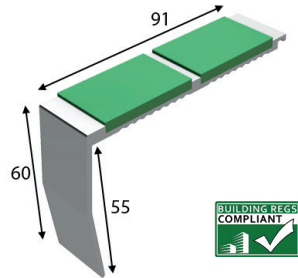

Double Channel Chevron
Fronted (medium)

HN14

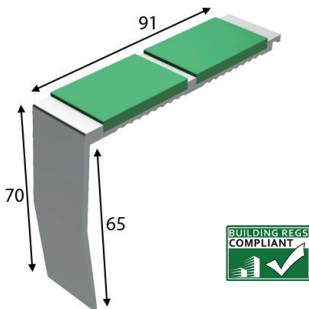

Double Channel Chevron
Fronted (large)

HN15

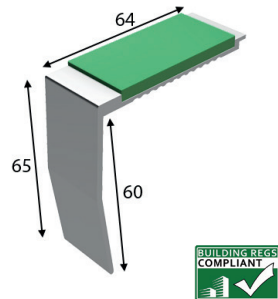

Single Channel Chevron
Fronted

Chevron fronted profiles can be used on narrow bullnose or square fronted staircases when fitting medium carpets and heavy duty smooth flooring

SN Range 90°

SN1

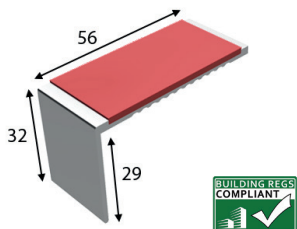

Single Channel 90° Straight

SN2

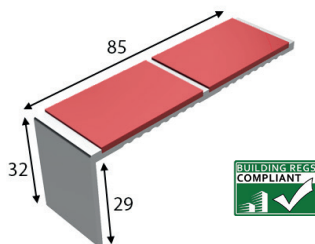

Double Channel 90° Straight

SN9

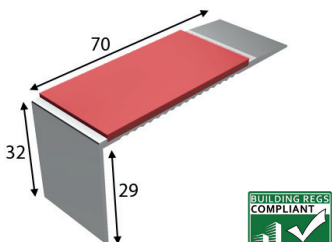

Single Channel Straight 90°
with Ramp

SN20

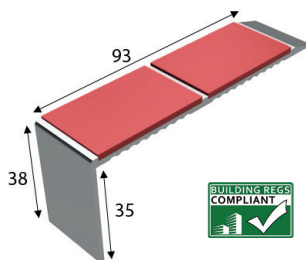

Double Channel 90° Straight
with Ramp

90° profiles for use on square fronted staircases when fitting thinner floorcoverings such as vinyl, lino & lightweight carpets.
Profiles with Ramp Back are also suitable for LVT

Suitable for use with MorGrip and Exterior Range.

SN Range Bullnose

SN3

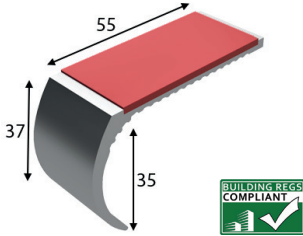

Single Channel Bullnose

SN4

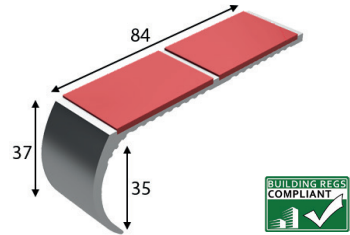

Double Channel Bullnose

SN17

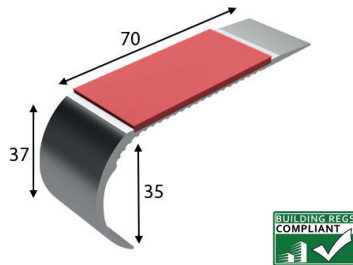

Single Channel Bullnose with Ramp

Bullnose profiles for use on bullnose staircases when fitting thinner floorcoverings such as vinyl, lino & lightweight carpets
Profiles with Ramp Back are also suitable for LVT

Suitable for use with MorGrip and Exterior Range.

SN Range Rakeback 83°

SN5

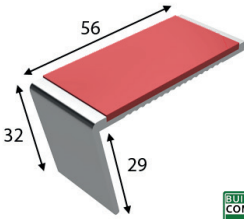

Single Channel 83° Rakeback

SN6

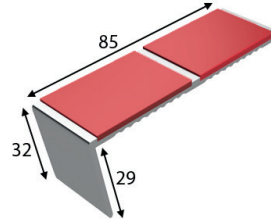

Double Channel 83° Rakeback

SN13

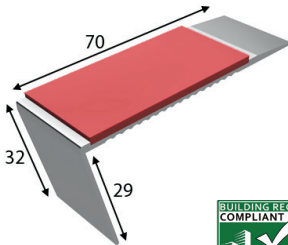

Single Channel 83° Rakeback
with Ramp

SN26

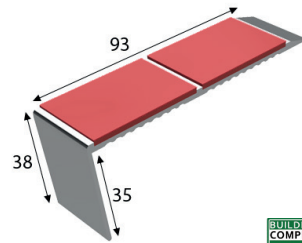

Double Channel 83° Rakeback
with Ramp

83° profiles for use on rakeback staircases when fitting thinner floorcoverings such as vinyl, lino & lightweight carpets.

Profiles with Ramp Back are also suitable for LVT

Suitable for use with MorGrip and Exterior Range.

Budget Range

SN7

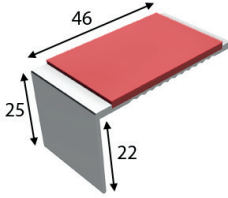

Single Channel 90° Straight

SN11

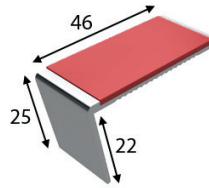

Single Channel 83° Rakeback

SN8

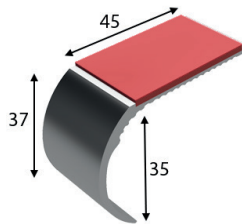

Single Channel Bullnose

Budget range nosings ideal for small domestic projects

Castellated

SN15

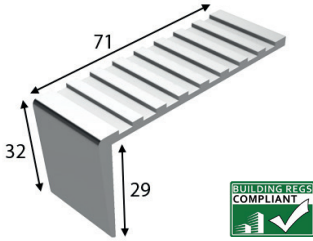

Castellated Top 90° Straight

SN19

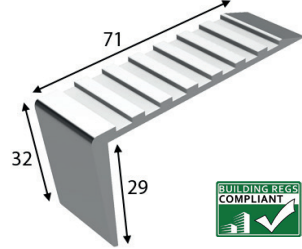

Castellated Top 90° Straight
with Ramp

90° profiles for use on exterior projects



HN7 Gold Mirrorreflect stair nosings were used on a staircase at
The Astor Court Hotel in London *pics (above)*

DDA Heavyweight Range

DISABILITY DISCRIMINATION ACT 2005

The Building Regulations require reasonable provision to be made for access to a building and use of facilities within a building. This can be achieved by following the principles of Approved Document M, or other recognised guidance such as BS8300. When undertaking building works or alterations, the design should therefore follow the guidance within such documents, noting any areas where compliance is not possible or practical within an Access Statement. This will provide a staircase or step that complies with the functional requirements of the Building Regulations.

DD1H

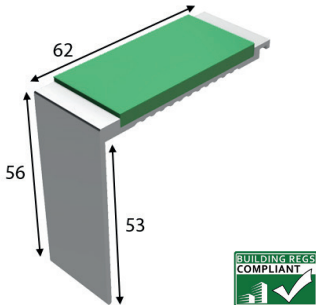

Single Channel Straight 90°

DD5H

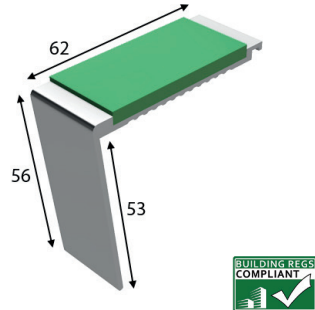

Single Channel 83° Rakeback

90° & 83° profiles for use on staircases when fitting medium carpets and heavy duty smooth flooring

DDA Slimline Range

DD1S

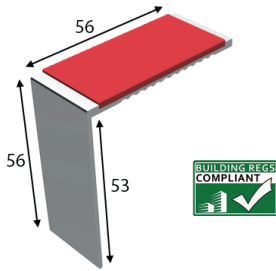

Single Channel Straight 90°

DD5S

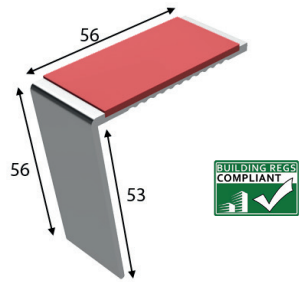

Single Channel 83° Rakeback

DD9S

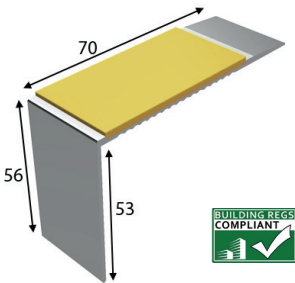

Single Channel Straight 90°
with Ramp

DD13S

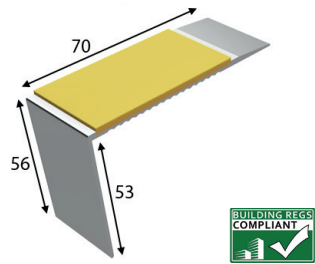

Single Channel 83° Rakeback
with Ramp

90° & 83° profiles for use on staircases when fitting thinner floorcoverings such as vinyl, lino & lightweight carpets. Profiles with Ramp Back are also suitable for LVT

Suitable for use with MorGrip and Exterior Range.

Premium Finishes

Elevate your nosing with one of our premium finishes.

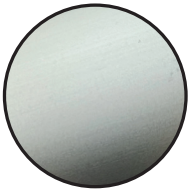

**Satin
Silver**

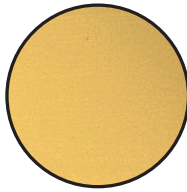

**Satin
Gold**

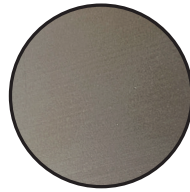

**Satin
Bronze**

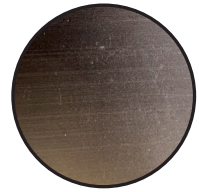

**Dark
Bronze**

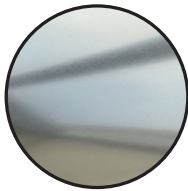

Mirrorflect

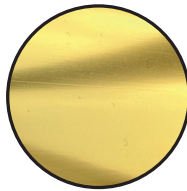

**Gold
Mirrorflect**



**Satin
Black**

Powder Coated Finishes also available for

Bespoke Projects

Colourful Alternatives

Full RAL colour range available

Special finishes for any aluminium product in this catalogue may be available upon request, any that are available will be subject subject to minimum quantities.

Lead time is normally 7 to 10 working days

Standard Insert Colours



Light Reflectance Value

LRV is a universal version for 'contrast'. Legislation (Equality Act 2010) requires that all new and refurbished public buildings and work places comply with current regulations via their 'Access Statement', ensuring safe entry, exit and safe passage throughout the building. A minimum of 30 points LRV difference is advised for adjacent surfaces.

MorGrip Insert Colours

Increased slip resistance in both wet and dry environments.
Improved performance in areas of heavy traffic and harsh conditions.
For internal use, with our SN Range.



Obsidian
(LRV 1.80)

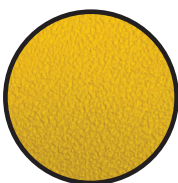

Solar
(LRV 55.10)



Rhino
(LRV 5.70)

Exterior Insert Colours

Specially designed for ultimate weather resistance and ant-slip properties
For external use, with our SN Range.



Coal
(LRV 5.09)



Brimstone
(LRV 54.24)

Other colours are available in project quantities

Angles

90°

ANG29

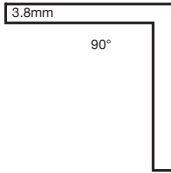

ANG39

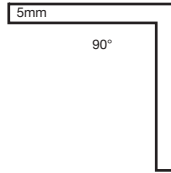

ANG69

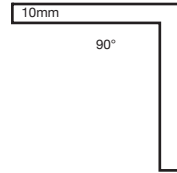

90° Welded angles (often called 'stringers') are available for use with straight 90° nosings.

83°

ANG28

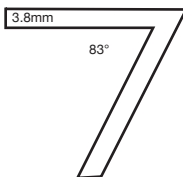

ANG38

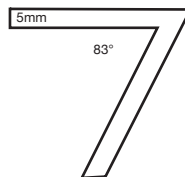

ANG68

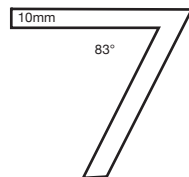

83° Welded angles (often called 'stringers') are available for use with rakeback 83° nosings.

Angle Trims

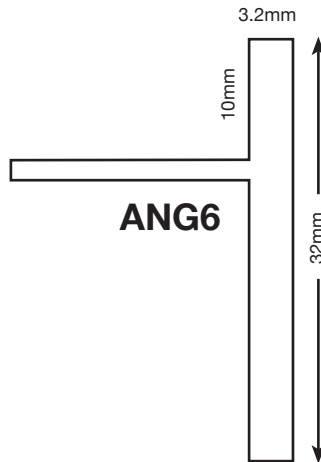
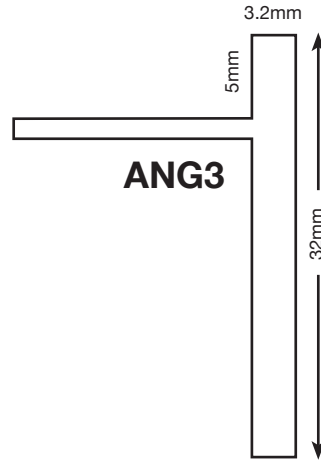
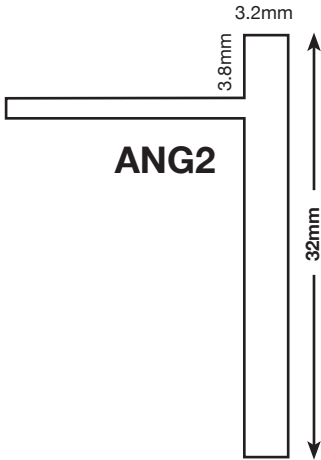

Fabrications

Curves



All profiles, apart from SN15 & SN19, can be supplied preformed into bends, curves or shapes. Orders for these must be accompanied by a pattern or template detailing the main dimensions and relevant information.

Please note that preformed sections are normally supplied at least 25mm oversized, this is to allow for trimming on site.

Mitres

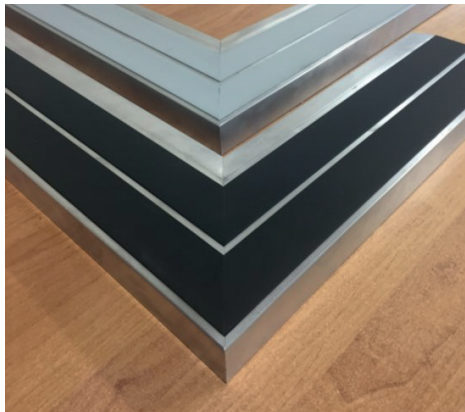

All profiles can be mitred and welded. Drawings or templates will be required for these.

Installation

Stair Nosings Installation Instructions

- Ensure that the stairs are flat, making good any irregularities
- Remove any debris and make sure that the stairs are clean
- Check the stair nosing is a good fit by placing on the correct stair
- Ensure the stair nosing is pushed up hard against the riser, then mark through the drill holes
- Remove the stair nosing then drill and plug where you have marked
- Apply adhesive to underside of the stair nosing if required, then reposition onto the step, allow adhesive to cure
- Screw down the stair nosing firmly
- Apply the insert plug to hide the screw

morleys

Stairnosings, Flooring Adhesives & Accessories

www.morleys-stairnosings.co.uk
01772 626700

Maintenance

Stair Nosings & Trim Maintenance

- To ensure the Stairnosings keep their appearance, they should be cleaned weekly, more frequently in areas of heavy traffic.
- Build-up of dirt and grease can prove hazardous.
- Inserts should be cleaned with a mild detergent diluted with water on a slightly damp cloth.
- Leave for a few minutes to break up soilage, then wipe off with a clean damp cloth.
- Allow to dry before use to avoid any slip hazard
- Aluminium can be lightly brushed with steel wool.
- Polishes will reduce anti-slip properties and solvent cleaners are not suitable.
- Strong detergents must not be used on stairnosing inserts as this may cause fading of the insert colour.
- Please avoid steam cleaning



[@morleys_uk](https://twitter.com/morleys_uk)

sales@morleys2013.co.uk

Measuring Service

Take the pressure off your project, ensuring you get the correct profile, at the correct sizes, with no wastage.



Call 01772 626700 to book
our **FAST, FREE** measuring service

Section 2. Carpet Metals



Product Sizes

Carpet Metals available in stock lengths of 2.70mtr & 900mm unless otherwise stated

Naplocks

Dual Edge

5S or 5G Dual Edge Double Naptrim is used to provide a safe, smooth transition between two meeting carpets or tiles of the same or similar height. This product can be supplied punched or unpunched.

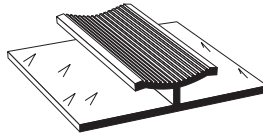

Available Finishes

- Standard (mill finish)
- Satin Silver
- Satin Gold
- Satin / Dark Bronze*
- Satin Black*

* Subject to minimum quantities

Naplocks

Single Edge

6S or 6G Single Edge Naptrim is used to secure and protect the raw edge of a carpet at the point where it meets a resilient or hard floor. This product can be supplied punched or unpunched.

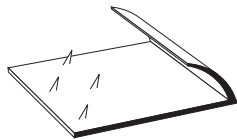

Available Finishes

- Standard (mill finish)
- Satin Silver
- Satin Gold
- Satin / Dark Bronze*
- Satin Black*

Heavy Duty Dual Edge

18S or 18G Heavy Duty Dual Edge Naptrim Raised Base Double is used to provide a safe, smooth transition between two meeting carpets or tiles of the same or similar height. This product can be supplied punched or unpunched.

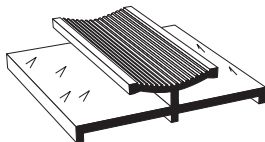

Available Finishes

- Standard (mill finish)
- Satin Silver
- Satin Gold
- Satin / Dark Bronze*
- Satin Black*

Heavy Duty Single Edge

23S or 23G Heavy Duty Single Edge Naptrim is used to secure and protect the raw edge of a carpet at the point where it meets a resilient or hard floor. This product can be supplied punched or unpunched.

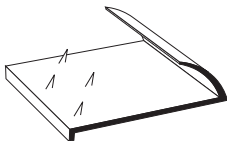

Available Finishes

- Standard (mill finish)
- Satin Silver
- Satin Gold
- Satin / Dark Bronze*
- Satin Black*

* Subject to minimum quantities

Cover Strips

Carpet Cover

1S or 1G Carpet Cover is used to provide a safe, smooth transition for both pedestrian and wheeled traffic.

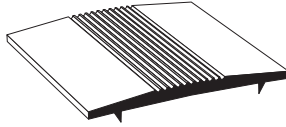

This product is often utilised as a bridge at the point where two carpets of the same or similar height meet. They can be supplied drilled or undrilled.

Available Finishes

- Standard (mill finish)
- Satin Silver
- Satin Gold
- Satin / Dark Bronze*
- Satin Black*

Large Lino Cover

2S or 2G Large Lino Cover is used to provide a safe, smooth transition for both pedestrian and wheeled traffic at the point where two areas of vinyl or lino meet. This product covers a greater surface area reducing wear at the join of the two floorcoverings. They can be supplied drilled or undrilled.

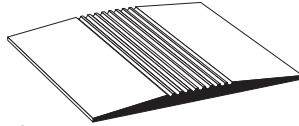

Available Finishes

- Standard (mill finish)
- Satin Silver
- Satin Gold
- Satin / Dark Bronze*
- Satin Black*

Lino Cover

3S or 3G Lino Cover is used to provide a safe, smooth transition for both pedestrian and wheeled traffic at the point where two areas of vinyl or lino meet. This product is usually used at door or room thresholds. They can be supplied drilled or undrilled.

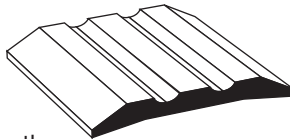

Available Finishes

- Standard (mill finish)
- Satin Silver
- Satin Gold
- Satin / Dark Bronze*
- Satin Black*

* Subject to minimum quantities

Cover Strips

Small Lino Edge

4S or 4G Small Lino Edge is used for sitting on top of the carpet, wood or laminate flooring up to 3.2mm thick.

This profile provides a diminishing finish down to hard flooring. When fitting leave a gap for expansion. This product can be supplied drilled or undrilled.

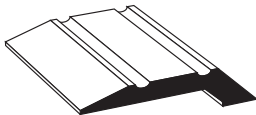

Available Finishes

- Standard (mill finish)
- Satin Silver
- Satin Gold
- Satin / Dark Bronze*
- Satin Black*

Medium Lino Edge

14S or 14G Medium Lino Edge is used for sitting on top of the carpet, wood or laminate flooring up to 4.5mm thick.

This profile provides a diminishing finish down to hard flooring. When fitting leave a gap for expansion. This product can be supplied drilled or undrilled.

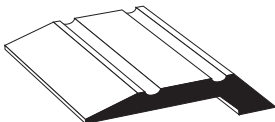

Available Finishes

- Standard (mill finish)
- Satin Silver
- Satin Gold
- Satin / Dark Bronze*
- Satin Black*

Wide Cover 61mm

20S or 20G Wide Cover 61mm is used to provide a safe, smooth transition for both pedestrian and wheeled traffic. This product is often utilised as a bridge at the point where two carpets of the same or similar height meet. They can be supplied drilled or undrilled.

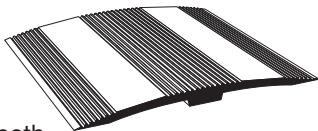

Available Finishes

- Standard (mill finish)
- Satin Silver
- Satin Gold
- Satin / Dark Bronze*
- Satin Black*

* Subject to minimum quantities

Special Purpose

Z Edge 8mm

ZES or ZESG Z Edge 8mm is used to secure and protect the raw edge of a carpet joining any wood or laminate flooring up to 9mm thick. This product can be supplied punched or unpunched. Leave gap for expansion.

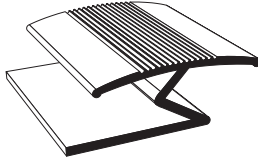

Available Finishes

- Standard (mill finish)
- Satin Silver
- Satin Gold
- Satin / Dark Bronze*
- Satin Black*



Z Edge profiles—Great for joining wood or laminate to carpet.

Z Edge 14mm

ZEL or ZELG Z Edge 14mm is used to secure and protect the raw edge of a carpet joining any wood or laminate flooring up to 15mm thick. This product can be supplied punched or unpunched. Leave gap for expansion.

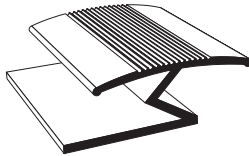

Available Finishes

- Standard (mill finish)
- Satin Silver
- Satin Gold
- Satin / Dark Bronze*
- Satin Black*

* Subject to minimum quantities

Special Purpose

Square Edge

9S or 9G Square Edge Naptrim is used to secure and protect the raw edge of a carpet joining any carpet, wood or laminate flooring up to 9mm thick. This product can be supplied punched or unpunched.

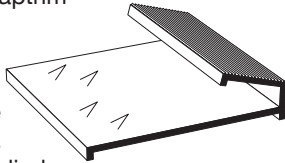

Available Finishes

- Standard (mill finish)
- Satin Silver
- Satin Gold
- Satin / Dark Bronze*
- Satin Black*

Matwell Edge

11S or 11G Matwell Edge is used for edging a recessed door mat. The product is a 90° angle, heavily ribbed for a non-slip finish and can be supplied drilled or undrilled.

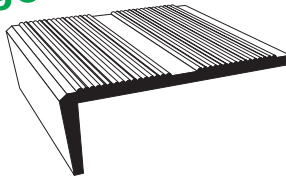

Available Finishes

- Standard (mill finish)
- Satin Silver
- Satin Gold
- Satin / Dark Bronze*
- Satin Black*

1" Angle Edge

12S or 12G 1" Angle Edge is an inch by inch aluminium edge suitable for platform installations. The product is a 90° angle and can be supplied drilled or undrilled.

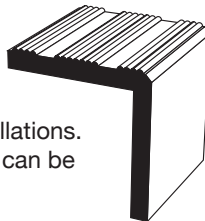

Available Finishes

- Standard (mill finish)
- Satin Silver
- Satin Gold
- Satin / Dark Bronze*
- Satin Black*

Section 3.

Stickdown Profiles

Finishes available:-

Satin Silver / Satin Gold / Satin Bronze / Dark Bronze / Satin Black

Morleys Stickdown range is a quick and easy way to finish laminate and wood flooring installations. Double-sided gel tape on the underside of the profile allows the profile to be stuck onto the flooring after it has been fitted. Suitable for both 8mm and 14mm laminate and wood. Standard lengths are 2700mm but all can be supplied in 900mm

NE1 Straight Edge Trim 8mm

Stickdown Edge Trim 8mm is for use with 8mm laminate installations to edge around the room against the skirting board, on the stairs or around a fireplace.

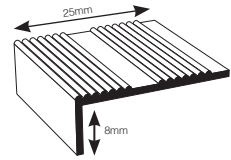

NE2 Straight Edge Trim 14mm

Stickdown Edge Trim 14mm is for use with 14mm thick wood or laminate installations to edge around the room against the skirting board, on the stairs or around a fireplace.

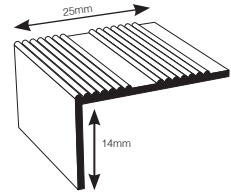

NE3 Parquet Edge 8mm

Stickdown Parquet Edge 8mm is used for sitting on top of wood or laminate flooring up to 8mm thick. This profile provides a diminishing finish down to hard flooring. When fitting leave a gap for expansion.

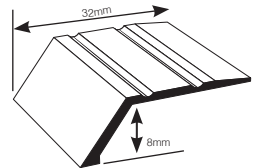

NE4 Parquet Edge 14mm

Stickdown Parquet Edge 14mm is used for sitting on top of the wood or laminate flooring up to 14mm thick. This profile provides a diminishing finish down to hard flooring. When fitting leave a gap for expansion.

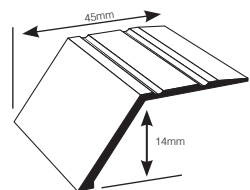

Stickdown Profiles

NE5 Wide Seam Cover Strip

Stickdown Cover Strip is used to cover the join where floorcoverings of the same or similar heights meet. It is a versatile strip but is predominantly used at door thresholds and laminate to laminate.

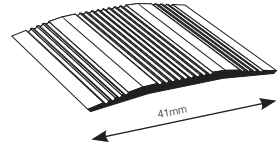

NE6 61mm Wide Seam Cover Strip

Stickdown 61mm Wide Cover is used to cover the join where floorcoverings of the same or similar heights meet. It is a versatile strip but is predominantly used at door thresholds and laminate to laminate.

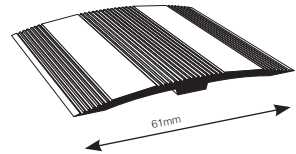

NE7 Medium Lino Edge Stickdown

Medium Lino Edge Stickdown is used for sitting on top of the carpet, wood or laminate flooring up to 4.5mm thick. This profile provides a diminishing finish down to hard flooring. When fitting leave a gap for expansion.

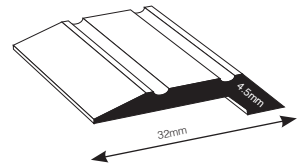

NE8 35mm Wide Smooth Cover

Stickdown 35mm Wide Smooth Cover Strip is used to cover the join where floorcoverings of the same or similar heights meet. It is a versatile 35mm wide strip most often used at door thresholds and laminate to laminate.

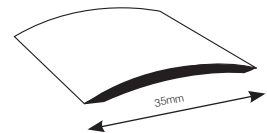

NE10 Small Lino Edge Stickdown

Small Lino Edge Stickdown is used for sitting on top of the carpet, wood or laminate flooring up to 3.2mm thick. This profile provides a diminishing finish down to hard flooring. When fitting leave a gap for expansion.

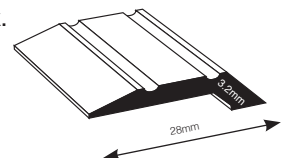

Accessories – Tapes

Safety Grip Tape / Adhesive Tape



Safety Grip Tape Colours Available:

Black, Green, Blue, Red, Yellow, Grey,
Transparent, Fluorescent
Hazard & Barrier 18.3 metres per roll
Available in the following widths:
25mm, 50mm, 75mm,
100mm & 150mm

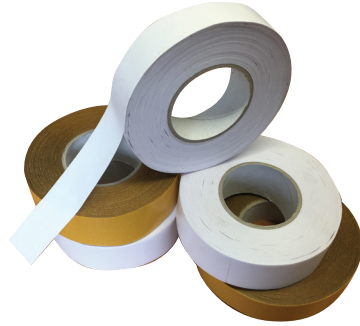

**Double sided tape
is available in
49mm & 37mm
(Roll size 66mtr)**

Fixing Solutions

**Fix your nosings using A17
for a fast, strong, visually clean installation.**

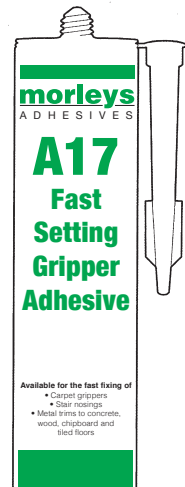

Adhesives range from

morleys

A D H E S I V E S



Contact us

In the office

Please call to speak to any of the sales team in our Preston office:



01772 626700



sales@morleys2013.co.uk



morleysstairnosings



Morleys 2013 Ltd



@Morleys_UK



www.morleys-stairnosings.co.uk



Check out our
full range by
scanning the QR code

In your area

Area Sales Representatives

London & South East

Paul Thomas 07799887305 paulthomas.morleys@gmail.com

North West of England & North Wales

Tom Walker 07767391960 tom@morleys2013.co.uk

Yorkshire & North East

Peter Zanetti 07836282845 p.zanetti@morleys2013.co.uk

South West of England & South Wales

Alan Coggins 07803514129 alcoggins.morleys@gmail.com

Midlands

Anders Perkins 07802918212 a20ajp@aol.com

Manufactured in Preston



From our head office in Preston we can deliver to the four corners of the UK
All of our products are available from your local distributor

sales@morleys2013.co.uk

morleys

Stairnosings, Flooring Adhesives & Accessories



Unit 20, Higher Walton Mill, Higher Walton, Preston PR5 4DJ
Tel: 01772 626700 www.morleys-stairnosings.co.uk

Manufactured in the UK

